

SCB1-3-25

**Surge Circuit Breaker**

The SCB1-3-25 is a purpose designed SPD disconnecter. It may be used to provide over current protection for any shunt connected SPD with an I_{max} rating up to 200kA or an I_{imp} rating to 25kA. The SCB1-3-25 is generally used at main switchboards. It effectively coordinates with any upstream supply circuit breaker or fuse.

Operation. All power line SPDs must be protected by an over current protective device (OCPD). Traditionally these have been fuses or circuit breakers but neither are really suitable to effectively protect the SPD in the event of its failure or in the event of a prolonged system overvoltage. Under normal operating conditions an SPD draws no more than a few milliamps of AC current from the supply but in the event of a transient disturbance it must instantly pass many thousands of amps. Fuses or circuit breakers chosen to pass this impulse current will not protect the SPD against an AC overvoltage nor necessarily prevent its failure to a short circuit before the fuse or circuit breaker trips. The fuses or circuit breaker ratings required to pass these impulse currents present coordination challenges with upstream OCPDs. The SCB1-3-25 is designed to trip at AC currents more than 3 amps but will pass impulse currents up to 25kA 10/350us. Tests have proven that the SCB will trip during a phase to phase voltage fault across a phase to neutral SPD with no damage to the SPD. The SCB may simply be reset. With a trip current of only 3A the SCB easily coordinates with upstream OCPDs. Novaris SPDs uniquely utilize electronic alarms and can detect the loss of supply due to tripping of the SCB.

Compatibility. The SCB1-3-25 can be used with all Novaris SD, SDN and SDEV products designed for LV distribution up to 200kA 8/20us rating and for SG products up to 25kA 10/350us.

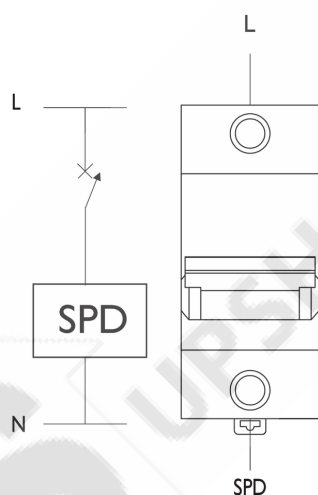
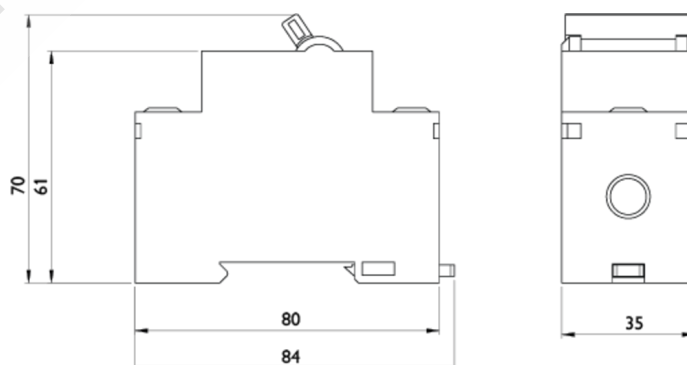
Wiring**Dimensions****Standards**













IEC61643-11 low voltage surge protection devices- requirements and tests IEC61643-11
IEC60898-1 Electrical accessories – circuit breakers for overcurrent protection IEC60898-1

Specifications

Electrical Specifications

Rated operating voltage	230VAC
Rated insulation voltage	400VAC
Impulse current withstanding (10/350 μ s)	25kA
Tripping value under power frequency current	3 \pm 1A
Rated service short-circuit breaking capacity	50kA
The breaking time of short-circuit power frequency current	<40ms
Mechanical life & Electrical life	1000 times

Mechanical Specifications

Minimum operating temperature		-25°C
Maximum operating temperature		60°C
Minimum operating humidity		5%
Maximum operating humidity		95%
Mounting method		TS35 DIN Rail
Environmental rating		IP20
Enclosure material		Polycarbonate
Enclosure finish		Green
Terminal capacity minimum		2.5mm ²
Terminal capacity maximum		25mm ²
Length		81mm
Width		35mm
Height		65mm

Other Specifications

Product Code  SCB1-3-25

Shipping Specifications

Weight  204g