

## Industrial Heavy Duty Non-hazardous Areas

### Applications:

Arktite circuit breaking plugs and receptacles are used:

- To supply power to portable electrically operated devices such as motor-generator sets, compressors, heating and cooling units, welders, conveyors, lighting systems and similar equipment
- Where temporary power is needed, such as at trailers, building units, heavy machinery and similar equipment
- Wherever electrical loads must be quickly disconnected from power source
- In a typical installation, where a large machine utilizes a number of electrical motor drives and for ease of adjustment, removal, maintenance and replacement, each motor is connected by portable cord and Arktite receptacles rather than permanently wired
- In areas where dust, dirt, moisture and corrosion are a problem
- Indoors and outdoors in non-hazardous areas of chemical plants, process industry facilities, meat packing plants, manufacturing plants and similar industrial locations

### Features:

- Circuit breaking: plugs through 100 ampere rating may be disconnected under load; 150-400 ampere units are for service disconnect use only.
- Receptacles accept only plugs of the same amperage rating, style and number of poles, making it impossible to mismatch, and provides for positive polarization.
- Extra wide electrical spacing allows for maximum safety.
- Insulator materials are the result of intensive testing. Selection has been made based on highest dielectric strength, maximum mechanical and impact resistance, lowest moisture absorption and highest arc tracking resistance.
- A variety of installations is possible due to the availability of several types of back boxes.
- Designed to withstand rough usage and the effects of adverse environments.
- Reversible interiors, 30, 60 and 100 ampere (except 30 and 60 ampere, 5-pole) Arktite plug and receptacle interiors are interchangeable using a screwdriver. This makes it possible to feed a normally de-energized receptacle from an energized plug with usual Arktite safety; no energized contacts are exposed.

### Certifications and Compliances:

- UL Standards: 1203\*; 1682, 1686
- CSA Standard: C22.2 No. 182.1
- CE (LVD) 2006/95/EEC\*\*

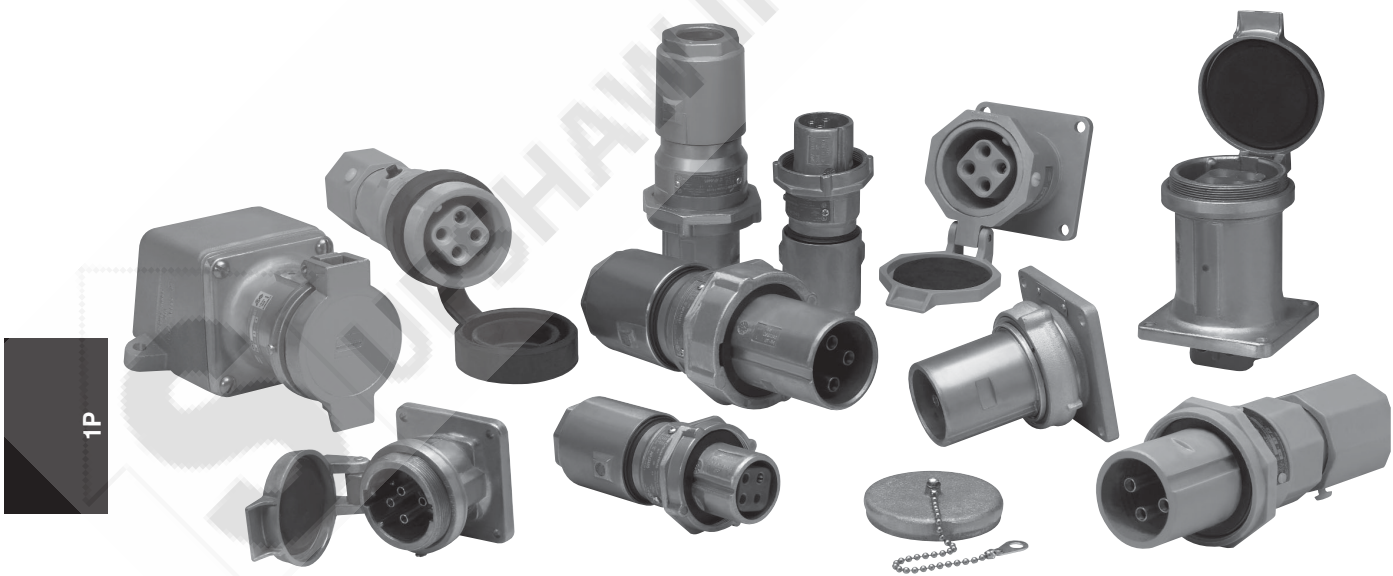

\* APJ and NPJ plugs only  
\*\* Excludes 200A and 400A APR Connectors

# Arktite® Heavy Duty Circuit Breaking Plugs and Receptacles

NEMA 4 Watertight

1P

## Industrial Heavy Duty Non-hazardous Areas

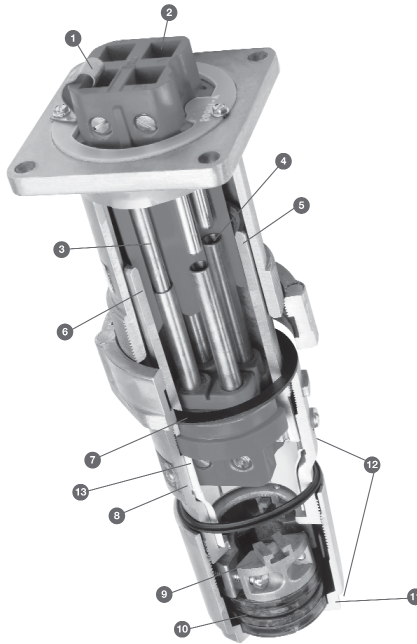

### Split Pin Contact Design:

- Provides nearly 360° of contact at every insertion, ensuring protection against heat rise and eliminating arcing on critical surfaces
- Continuous contact over length and circumference of mated pins provides superior safety and long-term performance
- Self-wiping at every insertion to prevent environmental contamination build-up



### The additional features below are called out in the illustration on this page

- 1 The ground contact is bonded to the receptacle housing (Style 2)
- 2 Unimpeded, easy-access phase and ground terminals make wire termination quick and easy
- 3 Grounding contacts that make-first and break-last in the unlikely event of keyway failure
- 4 An arc formed when the plug is being removed is instantly snuffed in the deep confined insulated arcing chamber
- 5 A detent spring forms a parallel grounding path through the metallic plug sleeve and receptacle housing and is the first contact to make and the last to break
- 6 The plug sleeve is keyed to the receptacle to prevent mispolarization
- 7 The gasketing system provides unsurpassed watertight integrity (NEMA 4)
- 8 All aluminum Uni-Shell™ construction provides superior strength in abusive environments
- 9 The Tri-Lock™ cable grip has 3-piece design that equally distributes gripping power around perimeter of cable. Cord jacket does not get pinched, eliminating potential for damage to both internal conductors and external cable jacket. Cable grip is located inside plug housing, eliminating corrosion of vital hardware and making plug maintenance easy.
- 10 The unique Sure-Seal™ cable gland has two gasket sizes which fit entire range of cable diameters, reducing risk of improper assembly. The gasket ratchets into the Tri-lock™ cable grip to prevent plug from turning or loosening in high vibration areas.
- 11 Wrenching surfaces make Arktite plugs quick and easy to assemble
- 12 Smooth and contoured design of plug housing eliminates occurrence of cable grip snagging or breaking off. Tri-Lock™ screws are captive so cable grip cannot come apart during assembly. Prevents critical screws from getting lost during installation.
- 13 Plastic sleeve between insulator body and housing minimizes possibility of electrical shock in event of ground failure. Increases creepage and clearance protection.

## Arktite® Advantage Features:

### Internal Plug Safety Insulator

- Plastic barrier between insulator body and metal housing minimizes risk of energizing handle body due to stray conductor strands
- Increases creepage and clearance protection

### CE Marked

- Offers a borderless solution with no additional inspection or documentation required for approval

### Lockout Plug

- Allows users to comply with OSHA lockout/tagout requirements
- Ensures plug cannot be inserted into receptacle when maintenance is being performed downstream of power supply

### Tri-Lock Cable Grip

- Three-piece design equally distributes grip around perimeter of cable
- Cable jacket does not get pinched, eliminating potential for damage to internal conductors
- Captive screws allow maximum extension of cord grip without risk of loose components

### Sure-Seal Cable Gland

- Two gasket sizes fit entire cable range, reducing risk of improper assembly
- Gasket ratches into Tri-Lock cable grip to provide environmental protection in high vibration areas

### Plug Housing

- Smooth design eliminates occurrence of cable grip snagging or breaking off
- Houses Tri-Lock cable grip to eliminate corrosion of vital hardware and increase ease of maintenance

### Combination Drive Stainless Steel Hardware

- Increases ease of installation by allowing for more than one option for installation tools
- Stainless steel external hardware eliminates corrosion on critical components and extends product life

### Insulator Assemblies

- Unimpeded, easy access phase and ground terminals make wire termination quick and easy
- Lug screws secured with tape to prevent them from vibrating loose and falling out during shipping

### Combination Slot and Hex Mechanical Lugs\*

- Increases ease of installation by allowing for more than one option for installation tools
- Hex head allows for easy achievement of specified torque value

### Receptacle Cover

- Automatic weatherproof seal every time plug is disengaged
- Field replaceable design allows for new cover to be threaded on quickly and easily

\*60, 100, and 150A offering.

# 1P Arktite® Heavy Duty Circuit Breaking Plugs and Receptacles

NEMA 4 Watertight

**Industrial Heavy Duty  
Non-hazardous Areas**

## Grounding: Style 1 vs. Style 2

Eaton's Crouse-Hinds Arktite devices utilize two methods, or styles, for completing the grounding circuit in plugs and receptacles. NEC reference 250.138 (A) & (B).

### Style 1 – Metallic

A Style 1 plug is one in which the grounding conductor in the flexible cable is bonded to the plug sleeve by a pressure connector. A Style 1 receptacle is one which is grounded by virtue of the fact that it is an integral part of a grounded conduit system. On insertion, the plug sleeve makes contact with detent springs of the grounded receptacle housing before line and load poles engage, and on withdrawal, remains in contact until after line and load poles disengage. Therefore, exposed metal parts of the portable equipment or plug are suitably grounded.

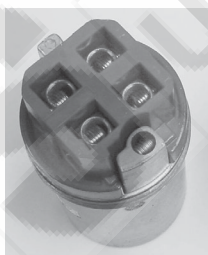
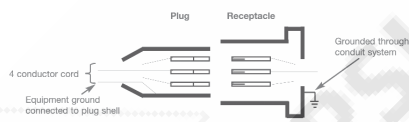
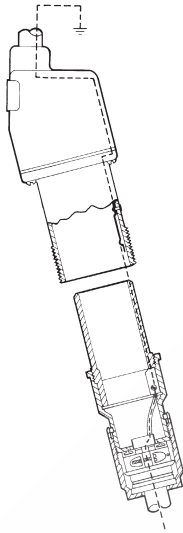

**Style 1**  
Ground conductor  
attaches to shell.

### Style 2 – Metallic

A Style 2 metallic housing plug is one in which the grounding conductor in the flexible cable is bonded to the extra (grounding) pole and metal plug sleeve by a pressure connector. A Style 2 metallic housing receptacle is one in which the extra (grounding) pole is electrically connected to the equipment grounding conductor and the metal receptacle housing which itself is grounded by virtue of the fact that it is an integral part of a grounded conduit system. In Style 2, non-metallic housing plugs and receptacles, the extra pole is used for grounding since the housings are non-conductive.

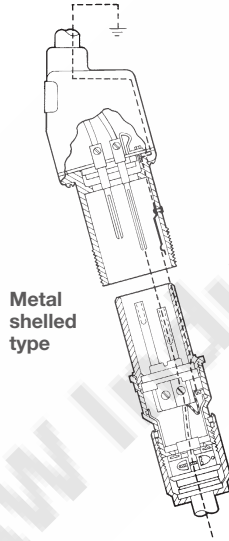

**Metal  
shelled  
type**

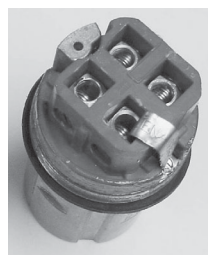
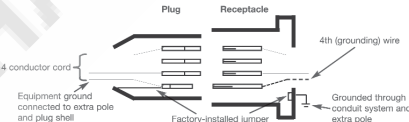

**Style 2**  
Ground conductor  
attaches to contact,  
which is bonded to  
shell.

### Style 2 – Non-metallic

In a Style 2 receptacle, the grounding connection is made before line and load poles engage, and is broken after the line load poles disengage. Furthermore, upon insertion, the plug sleeve of metal shelled units makes contact with detent springs of the grounded receptacle housing before line and load poles engage, and on withdrawal, remains in contact until after line and load poles disengage. Therefore, exposed metal parts of the portable equipment or plug are suitably grounded.

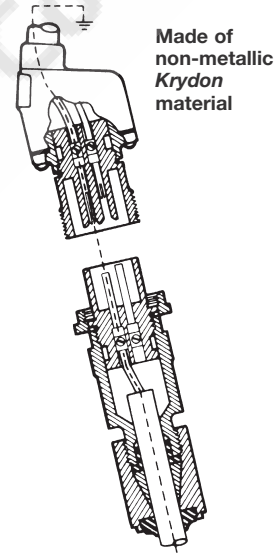

**Made of  
non-metallic  
Krydon  
material**

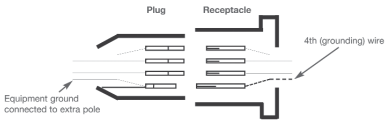

# Arktite® Heavy Duty Circuit Breaking Plugs and Receptacles

NEMA 4 Watertight

1P

## Industrial Heavy Duty Non-hazardous Areas

### Standard Materials:

- Metallic receptacle housings, plug and cord connector bodies – high impact strength copper-free aluminum
- Non-metallic receptacles, plugs and cord connectors – *Krydon*® fiberglass-reinforced polyester material
- Back boxes: 20, 30, 60, 100, 150 and 200 ampere – cast aluminum; 400 ampere – *Feraloy*® iron alloy
- Insulation (metallic products): (2-, 3-, and 4-pole) 30, 60, 100, 200, 400 ampere – fiberglass-reinforced polyester; 20, 30 ampere (5-pole) – melamine
- Contacts: pressure, solder, binding screw – brass; crimp/solder 20, 30, 60, 100 ampere – leaded red brass; crimp/solder 150, 200, 400 ampere – tellurium copper

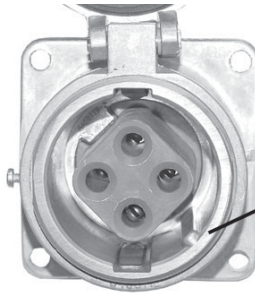

Arktite receptacles have a cast raised rib located inside the receptacle sleeve. The location of the rib is in a specific relationship to the receptacle insulator that houses the contacts.

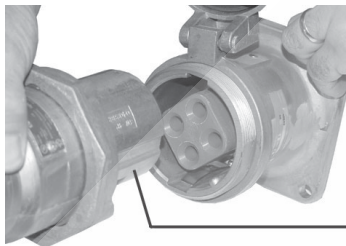

The mating plug has a cast groove located on the outside of the plug sleeve. This groove lines up with the raised rib.

### Standard Finishes:

- *Feraloy* – electrogalvanized and aluminum acrylic paint
- Aluminum – natural
- *Krydon* fiberglass-reinforced polyester material – gray
- Fiberglass-reinforced polyester insulation – (red)
- Melamine – natural (brown)
- Brass – natural
- Leaded red brass – electro-tin-plate

### Accessories:

- Accessories include a variety of angle adapters, panel adapters and back boxes for *Arktite* receptacles, see pages 1332–1335.
- Included throughout 1P are wire mesh cable grips and protective caps for *Arktite* plugs.

### Options:

The following special options are available from factory by adding the suffix to the Cat. #:

- | Description  | Suffix |
|--|--------|
| • Reversed contacts. Receptacle assembled with plug interior (exposed contacts), plug assembled with receptacle interior (recessed contacts). For applications where plug is energized to feed normally de-energized receptacle. Available on 30 through 400 ampere units... <b>S22</b>  |        |
| • Special polarity. For use where two or more receptacles of the same ampere rating, style and number of poles are to be installed in the same area for use on different voltages and/or frequencies. Prevents insertion of a plug in a receptacle with different electrical rating. Available on 20 through 400 ampere units as follows: <ul style="list-style-type: none"> <li>• Receptacle interior rotated 22½° to right and plug changed to match (see photo to right)..... <b>S4</b></li> <li>• Corro-free™ epoxy powder finish for added corrosion resistance..... <b>S752</b></li> </ul> |        |

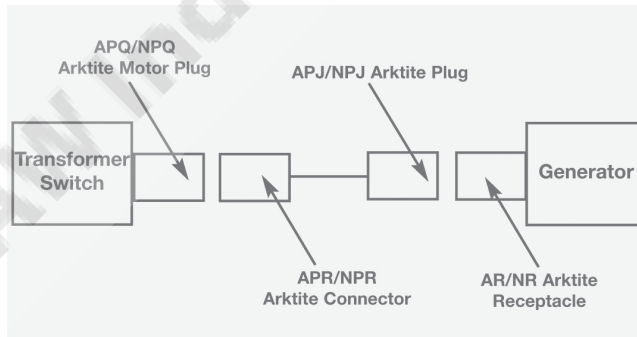

Typical Installation

§150A, 200A and 400A rated units are for service disconnect use only.

## Industrial Heavy Duty Non-hazardous Areas

### Arktite Horsepower Ratings Locked-Rotor Interrupting

Ampere Rating Plug and Receptacle	Motor Horsepower†			
	120 Volts	240 Volts	480 Volts	600 Volts
<b>Single-phase Electrical System</b>				
30	2	3	7.5	10
60	5	10	25	20
100	10	20		
200	15	40		
<b>Three-phase Electrical System</b>				
30	3	5	10	10
60	10	20	40	50
100	15	30	40	25
200	30	60	25	15

### Maximum Horsepower for Plug and Receptacle Combinations by Input Voltage\*

Following values are typical horsepower ratings based on NEC Article 430 tables.

HP Ratings are based on the largest conductor size for each plug and receptacle combination per the Wire Size table below.

Ampere Rating Plug and Receptacle	Motor Horsepower‡		
	240 Volts	480 Volts	600 Volts
30	15	30	40
60	20	40	50
100	30	60	75
150	40	75	100
200	60	125	150

### Wire Sizes:

The table below lists the diameter of the wire recess in *Arktite* plug and receptacle contacts so that maximum size of bare conductor can be figured. Range of wire sizes shown in table is intended only as a guide. Depending on type of wire used (building wire, flexible or extra flexible cable) and its construction (number and size of strands), bare copper diameters vary widely.

### Diameter of Wire Recess in Plug and Receptacle Contacts

Ampere Rating	Contact Type	Diameter of Recess	Wire Size‡	
			Building	Extra Flex
20	Binding Screw	N/A	#14-#12	#14-#12
30 (2, 3, & 4-pole)	Pressure	.281	#10-#6	#10-#8
30 (2, 3, & 4-pole)	Crimp/Solder	.180	#10-#8**	#10-#8
30 (5-pole)	Solder	.188	#12-#6	#12-#8
60 (2, 3, 4 & 5-pole)	Pressure	.312	#6-#4	#8-#4
60 (3 & 4-pole)	Crimp/Solder	.277	#6-#4**	#8-#4
100 (2, 3 & 4-pole)	Pressure	.390	#4-#1	#4-#2
100 (3 & 4-pole)	Crimp/Solder	.390	#2-#1**	#2-#2
150 (4-pole)	Pressure	.390	#2-2/0	#2-1/0
200 (3 & 4-pole)	Pressure	.687	2/0-4/0	2/0-3/0
200 (Std. 3 & 4-pole)	Crimp/Solder	.560	#1-4/0	#1-3/0
200 (Lg. 3 & 4-pole)	Crimp/Solder	.750	4/0-250MCM	3/0-250MCM
400 (Std. 3 & 4-pole)	Crimp/Solder	.840	250-500MCM	250-400MCM
400 (Lg. 3 & 4-pole)	Crimp/Solder	1.25	500-1000MCM	400-750MCM

§150A, 200A and 400A rated units are for service disconnect use only.

† Horsepower ratings are based on Eaton's Crouse-Hinds testing in which locked-rotor currents were interrupted by withdrawing the plug from the receptacle. It is highly recommended, however, that such use be limited to emergency conditions only, and that a horsepower rated switch be used for motor disconnect.

\* This guide is for reference only. Consult your local electrical codes before installation.

‡ Eaton's Crouse-Hinds does not recommend our plug and receptacle be used for disconnect under load.

\*\*Smaller sizes may be used with well reducers - information available upon request.

‡Do not use wire size smaller than minimum size recommended.

# 1P Arktite® Heavy Duty Circuit Breaking Receptacle Assemblies and Housings

NEMA 4 Watertight

100 A, 600 VAC/250 VDC, 50† – 400 hertz  
 150 A, 600 VAC/250 VDC, 50† – 400 hertz

## Ordering Information:



Receptacle Assembly

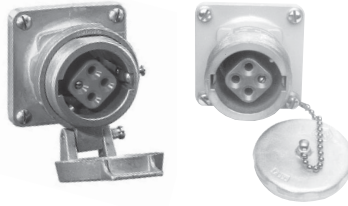

Receptacle

Receptacle Housings Only



Mating Plug



Mating Connector

Description	Hub Size (In.)	Spring Door Cat. #	Receptacle Housings Only		Cable Dia.	Cat. #	Cat. #
			Spring Door Cat. #	Threaded Cap Only Cat. #			
<b>100A - Style 1</b>							
2-wire, } 2-pole }	1¼	AREA10214	AR1021	AR1027	0.875 to 1.70	APJ10277	APR10257
	1½	AREA10215					
3-wire, } 3-pole }	1¼	AREA10314	AR1031	AR1037	0.875 to 1.70	APJ10377	APR10357
	1½	AREA10315					
4-wire, } 4-pole }	1½	AREA10415	AR1041	AR1047	0.875 to 1.70	APJ10477	APR10457
	2	AREA10416					
<b>100 A - Style 2</b>							
2-wire, } 3-pole }	1¼	AREA10324	AR1032	AR1038	0.875 to 1.70	APJ10387	APR10367
	1½	AREA10325					
3-wire, } 4-pole }	1½	AREA10425	AR1042	AR1048	0.875 to 1.70	APJ10487	APR10467
	2	AREA10426					
<b>150 A - Style 2 *</b>							
3-wire, } 4-pole }			AR1542	AR1548	0.875 to 1.70	APJ15487	

## Dimensions (In Inches):

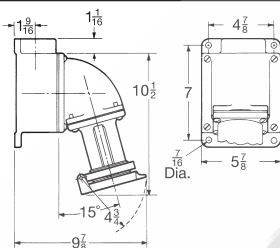

ARE Assembly

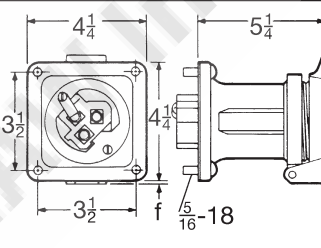

AR Receptacle - Spring Door

No. Poles	f
2 or 3	9/32
4	13/32

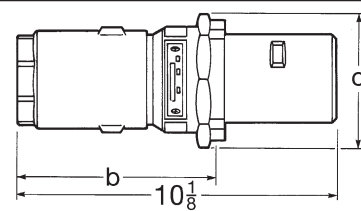

APJ Plug

No. Poles	b	c
3	6 5/16	3 3/4
4	6 5/8	4 1/8

No. Poles	Housing	c
2 or 3	open	3 3/16
4	open	3 7/16
2 or 3	with cap	3 11/16
4	with cap	3 7/8

No. Poles	b	c
3	3 3/8	3 3/16
4	3 1/2	3 7/16

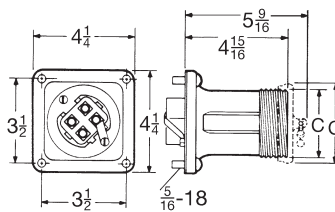

AR Receptacle - Open and With Cap

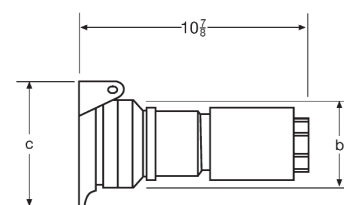

APR Connector

† For use on systems less than 60 hertz the receptacles, plugs and connectors are for disconnect use only.  
 \* For 150A - Consult factory for additional options and configurations. Consult factory for certifications information.

# Arktite® Heavy Duty Circuit Breaking Receptacle Assemblies and Housings

NEMA 4 Watertight

1P

100 A, 600 VAC/250 VDC, 50† – 400 hertz  
 150 A, 600 VAC/250 VDC, 50† – 400 hertz

## Plug Closure Caps:

### Applications:

CPK caps for Arktite plugs are used:

- Where portable equipment is on a standby basis and plugs are not in use
- To effectively protect insulation and contacts from excessive moisture, dirt, dust and corrosion
- With 30, 60, 100, 150 and 200 ampere plugs with fastening ring and standard 200 ampere plugs for the clamp door housing



### Ordering Information

Config.	Cat. #
2P & 3P	CPK62
4P	CPK64

### Standard Materials:

- Copper-free aluminum

### Standard Finishes:

- Natural

### Replacement Parts:

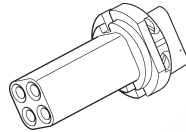

Receptacle Interior

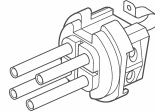

Plug Interior



Spring Door



Screw Cap

Config.	Receptacle Interior	Plug Interior	Spring Door	Screw Cap
2W 2P	ATP315	ATP310		
2W 3P	ATP318	ATP313	QE53	QE62
3W 3P	ATP316	ATP311		
3W 4P	ATP319	ATP314	QE54	QE64
4W 4P	ATP317	ATP312		
4W 5P	N/A	N/A	N/A	N/A
5W 5P	N/A	N/A	N/A	N/A

### Replacement Pin & Sleeve Contacts:

Description	Recep	Plug
Available as a kit only. 5 phase contacts & 1 ground contact included.	AR100CONKIT	AP100CONKIT

† For use on systems less than 60 hertz the receptacles, plugs and connectors are for disconnect use only.